

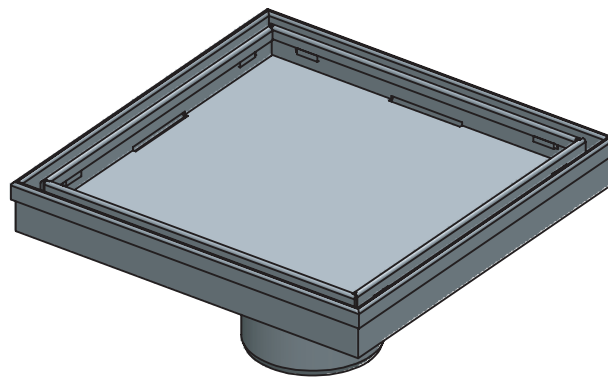

# Installation Manual - 10.SQD.0606

## 6" Tile Insert Drain



### **BEFORE YOU BEGIN**

- You must observe all local plumbing laws and codes.
- Do not install this Drain if it does not meet local plumbing codes.
- Shut off the main water supply.

## TABLE OF CONTENTS

• Rough in Specifications . . . . .	1
• Drain Installation . . . . .	2
• Cleaning Instruction . . . . .	2

## NOTICE TO HOMEOWNER

- We recommend that this product is installed by a qualified professional plumber.
- Please check this product immediately to ensure that it has not been damaged and is complete. Before installation, please make sure this product is the correct model and you have all the parts required for installation and use.
- Please flush the water system to ensure that no metal swarf, solder, and other impurities can enter the product.
- Turn off water supply before commencing work.
- Please read these instructions carefully and retain for future reference.

ROUGH IN SPECIFICATION

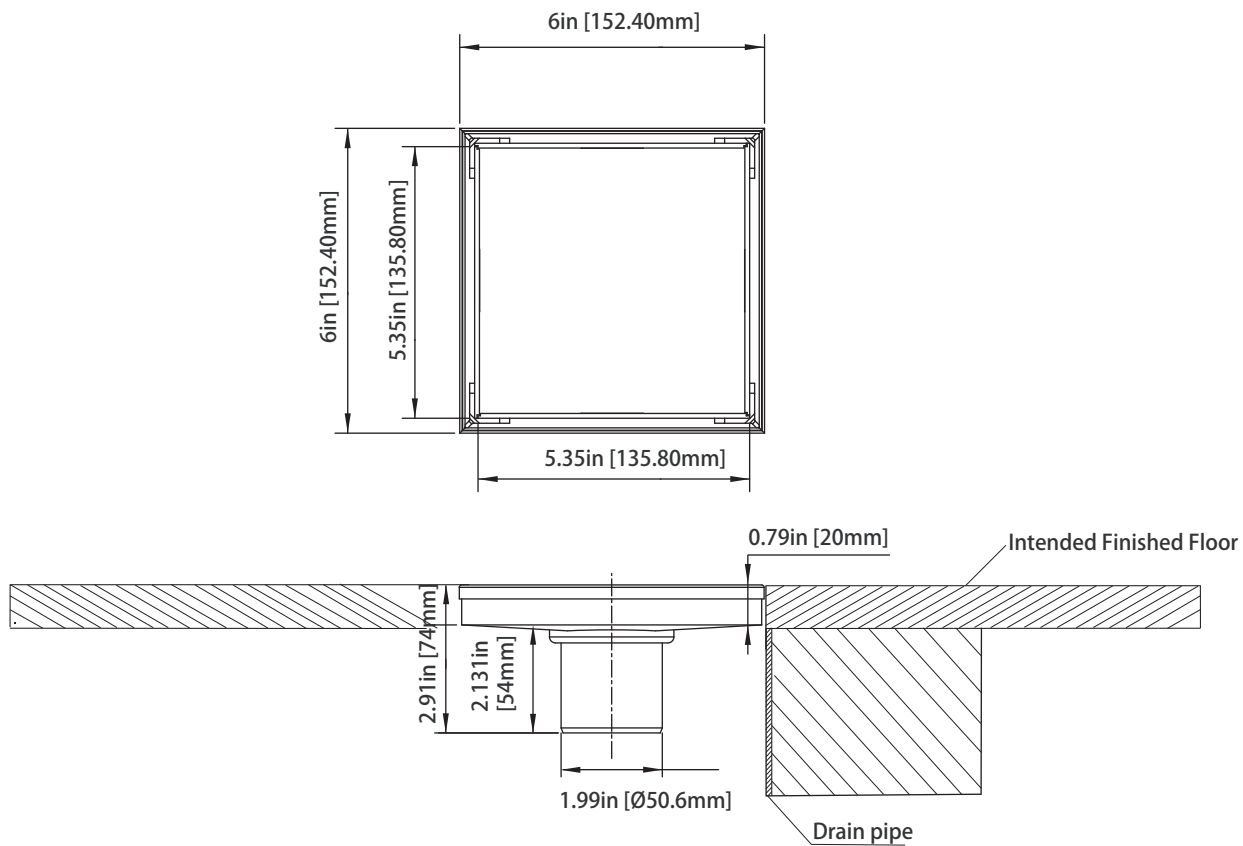

## INSTALLATION

To drain easily, the mounting position of floor drain must be at the lowest area of the whole finished floor.

Determine the height of prearranged stub-out according to the diameter of drain pipe and the height of intended finished floor.

Mount the floor drain according to the determined height. Position it. Fill up the interspace around it with cement.

The size of opening on the tile is as the figure shown. Lay the tile.

Fill up the gap between the floor drain and tile with cement. Remove any excess cement.

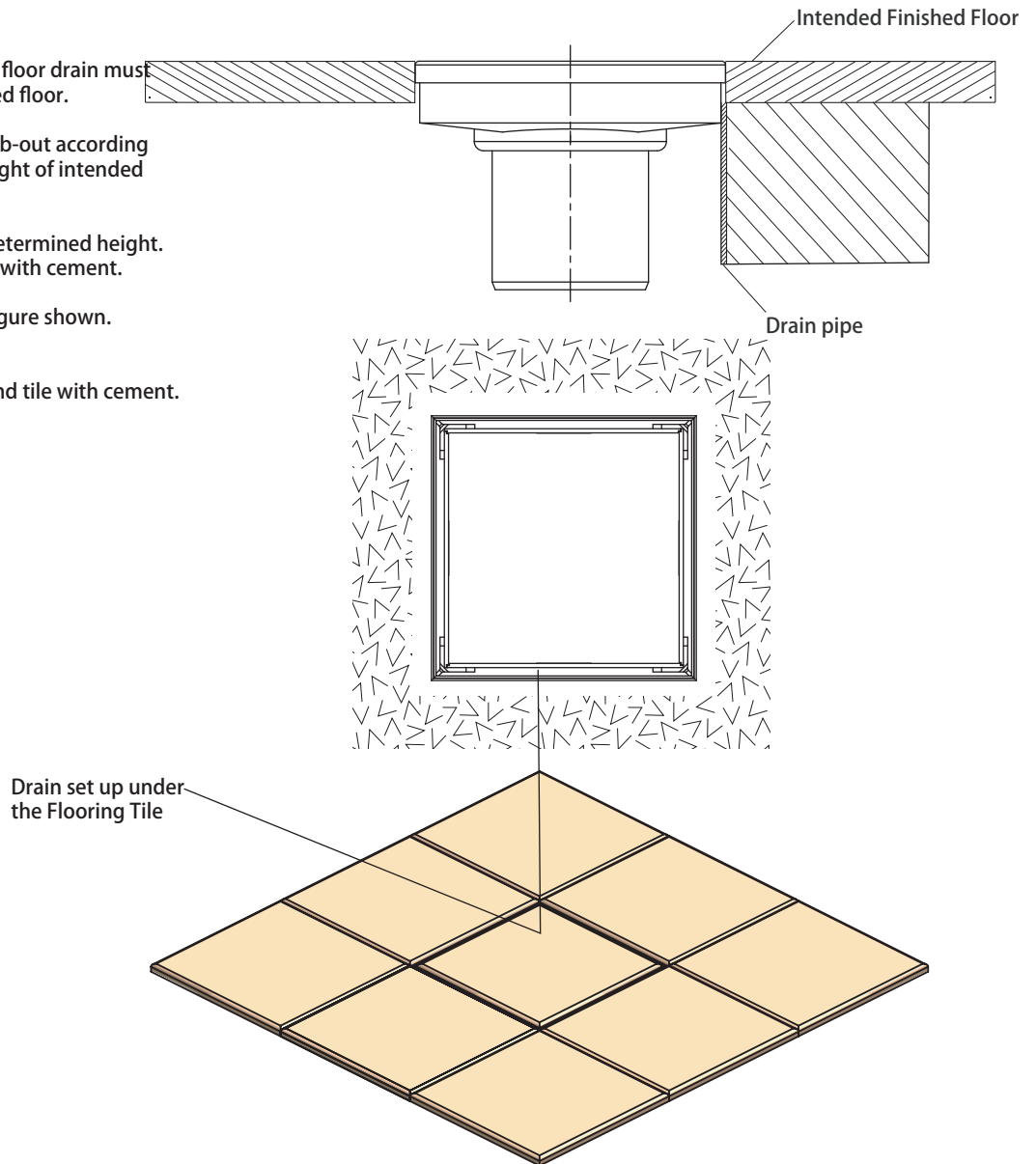

## CLEANING INSTRUCTION

All Finishes: Clean the finish with mild soap and warm water. Wipe entire surface completely dry with clean soft cloth. Many cleaners may contain chemicals, such as ammonia, chlorine, toilet cleaner etc. which could adversely affect the finish and are not recommended for cleaning.

Do not use abrasive cleaners or solvents on isenberg faucets and fittings.

SERVICE PARTS

