

Installation Manual For 100.1000 - Single Hole Faucet

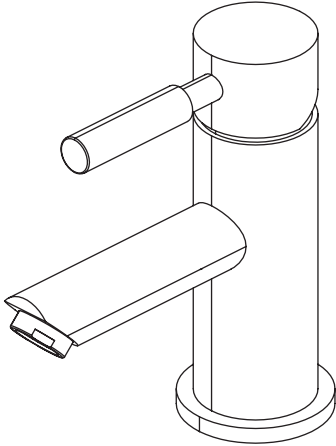

NOTICE TO HOMEOWNER

- We recommend that this product is installed by a qualified professional plumber.
- Please check this product immediately to ensure that it has not been damaged and is complete. Before installation, please make sure this product is the correct model and you have all the parts required for installation and use.
- Please flush the water system to ensure that no metal swarf, solder, and other impurities can enter the product.
- Turn off water supply before commencing work.
- Please read these instructions carefully and retain for future reference.

TABLE OF CONTENTS

- Installing The Faucet 1

BEFORE YOU BEGIN

- You must observe all local plumbing laws and codes.
- Do not install this product if it does not meet plumbing codes.
- Shut off the main water supply.

INSTALLING THE SINGLE HOLE FAUCET

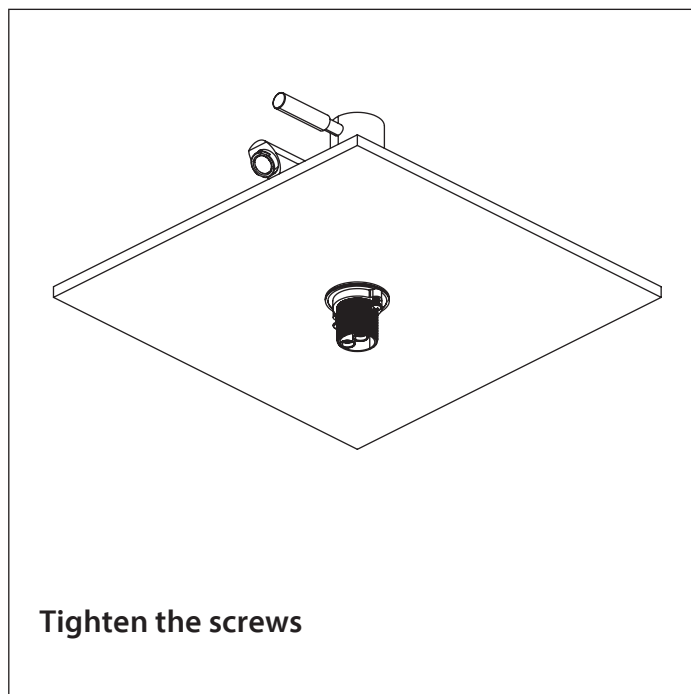
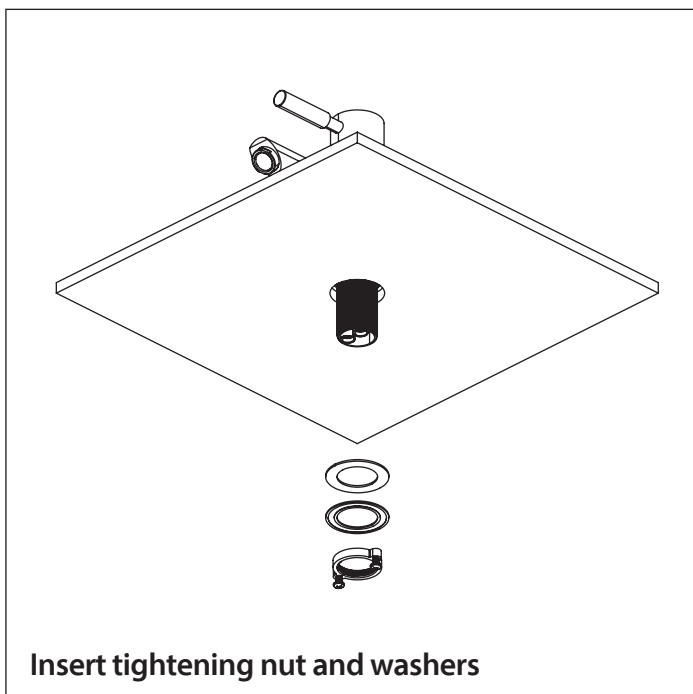
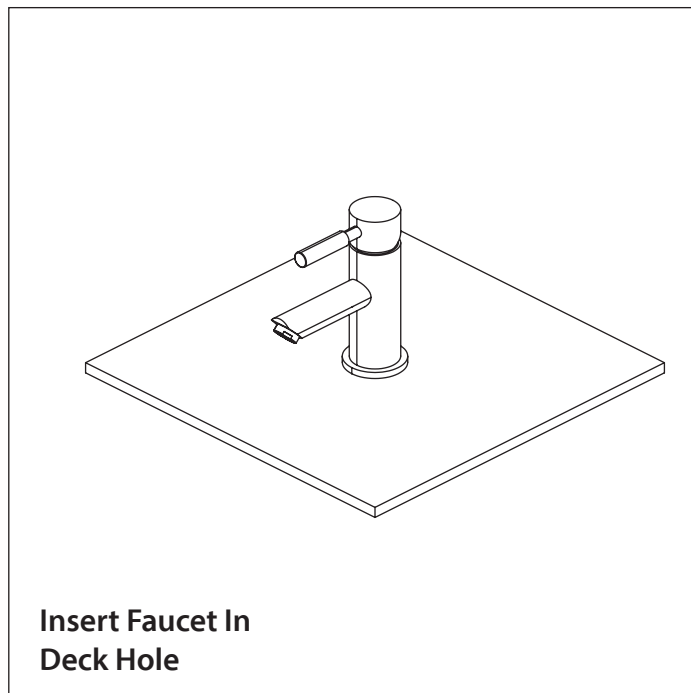
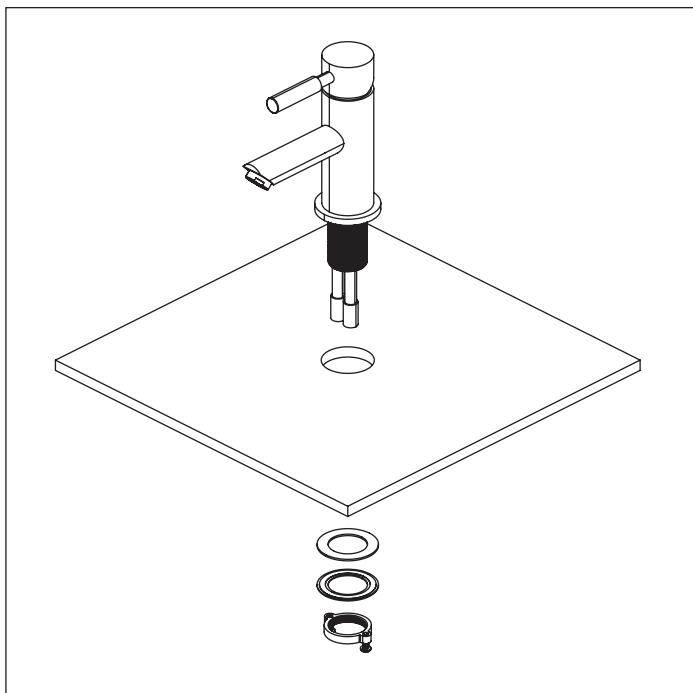

INSTALLING THE SINGLE HOLE FAUCET

