

Installation Manual For 230.1000 - Single Hole Faucet

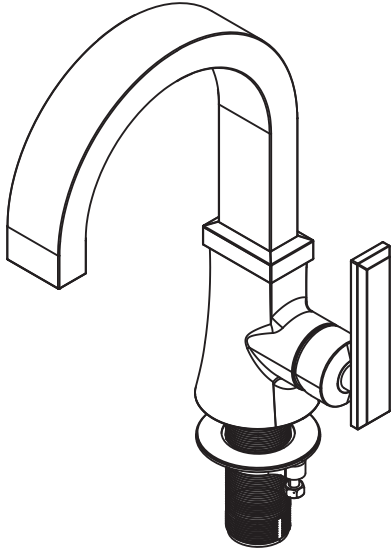

NOTICE TO HOMEOWNER

- We recommend that this product is installed by a qualified professional plumber.
- Please check this product immediately to ensure that it has not been damaged and is complete. Before installation, please make sure this product is the correct model and you have all the parts required for installation and use.
- Please flush the water system to ensure that no metal swarf, solder, and other impurities can enter the product.
- Turn off water supply before commencing work.
- Please read these instructions carefully and retain for future reference.

BEFORE YOU BEGIN

- You must observe all local plumbing laws and codes.
- Do not install this product if it does not meet plumbing codes.
- Shut off the main water supply.

INSTALLING THE SINGLE HOLE FAUCET

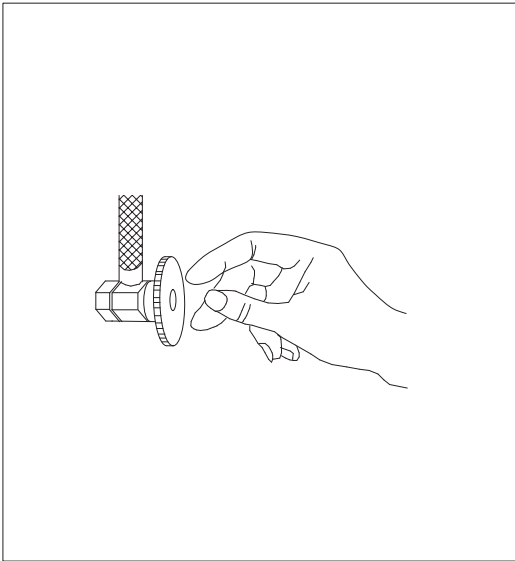

Step 1

Shut off water supply. Remove old faucet. Clean the surface in preparation for new faucet.

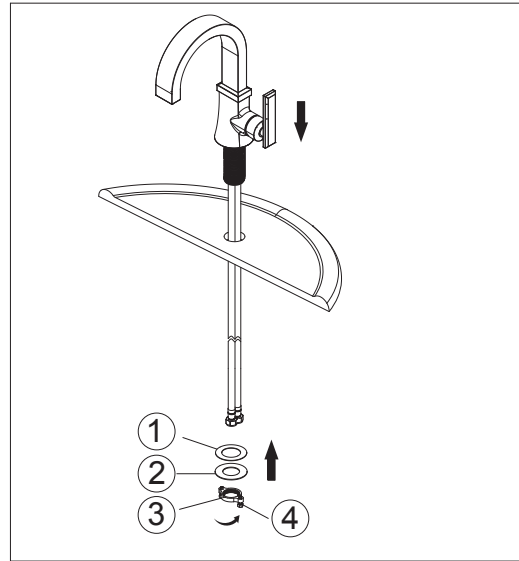

Step 2

Place new faucet through hole on top of sink. Install the rubber washer (1), and metal washer (2) onto the threaded mounting shank. Thread the nut (3) onto the mounting shank. Lock the nut (3) into position by tightening the screws (4). Do not overtighten.

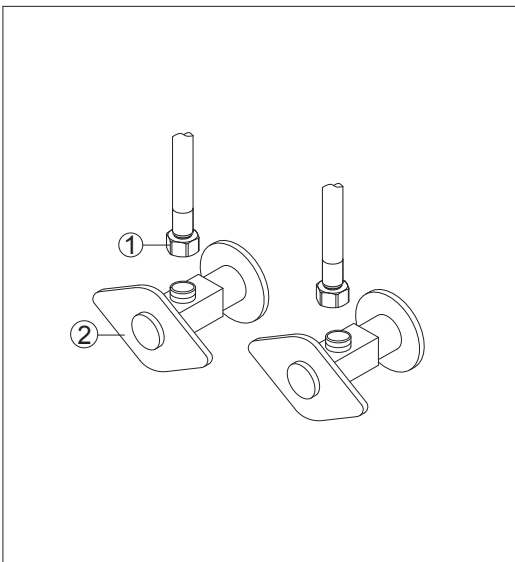

Step 3

Thread the nut (1) on supply line onto outlet of water supply valve (2) and tighten with wrench. Do not overtighten.

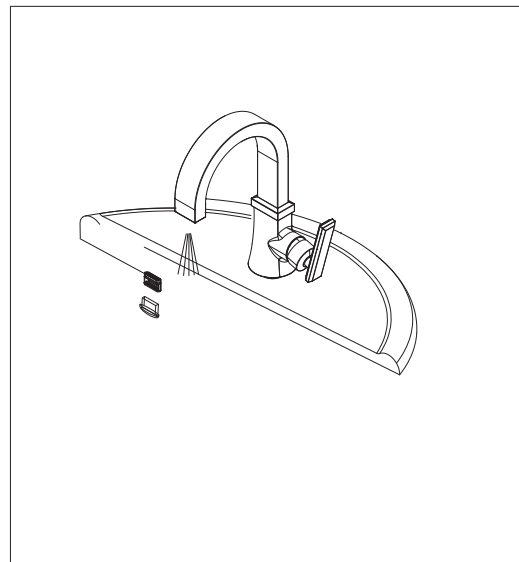

Step 4

Important: After installation is completed, remove aerator with plastic wrench. Turn on water supply and allow both hot and cold water to run for at least one minute each. While water is running, check for leaks. Replace aerator. This flushes away any debris that could cause damage to internal parts.