

Product Parts Breakdown

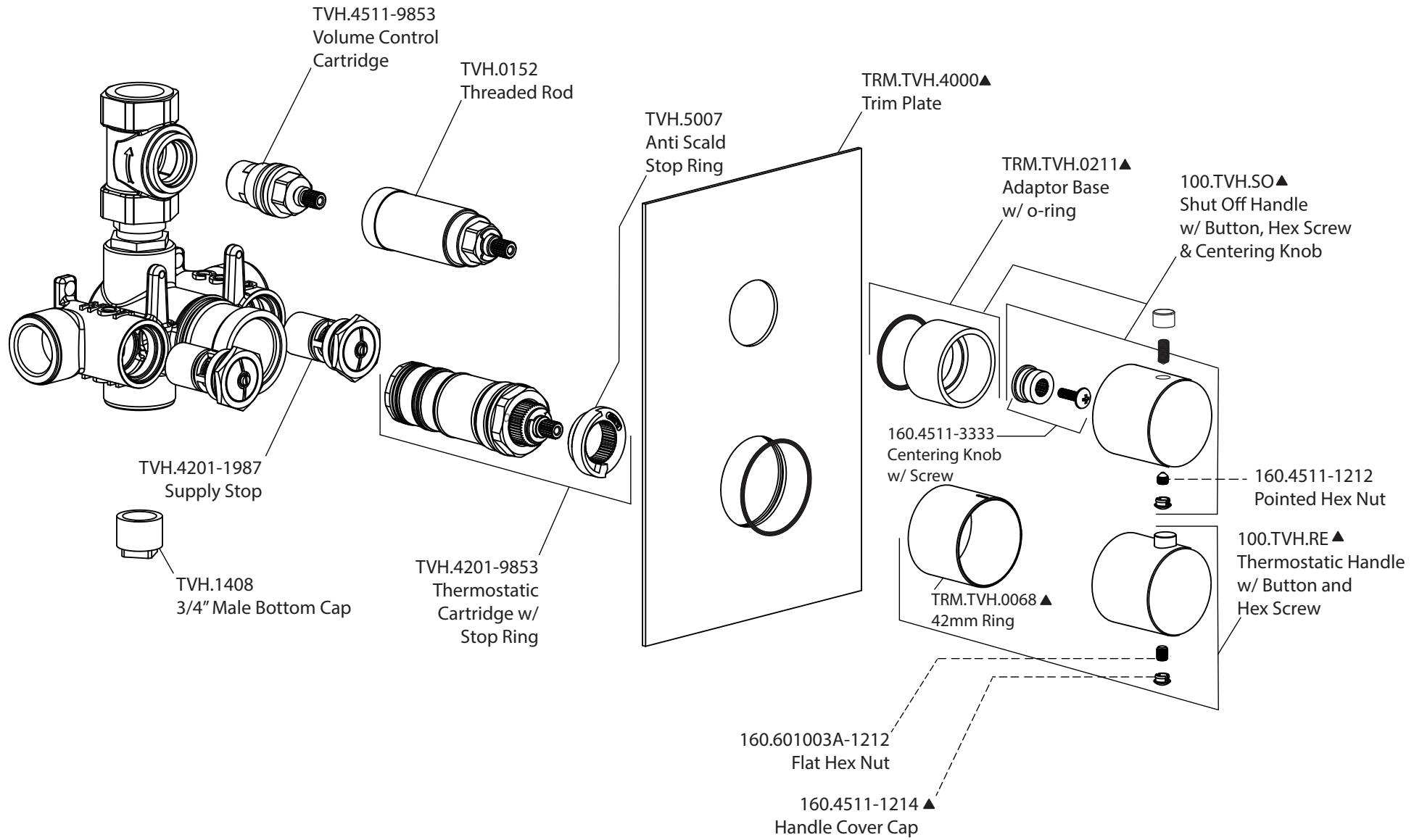

Model No. 100.4101

Ver 2.56