

Product Parts Breakdown

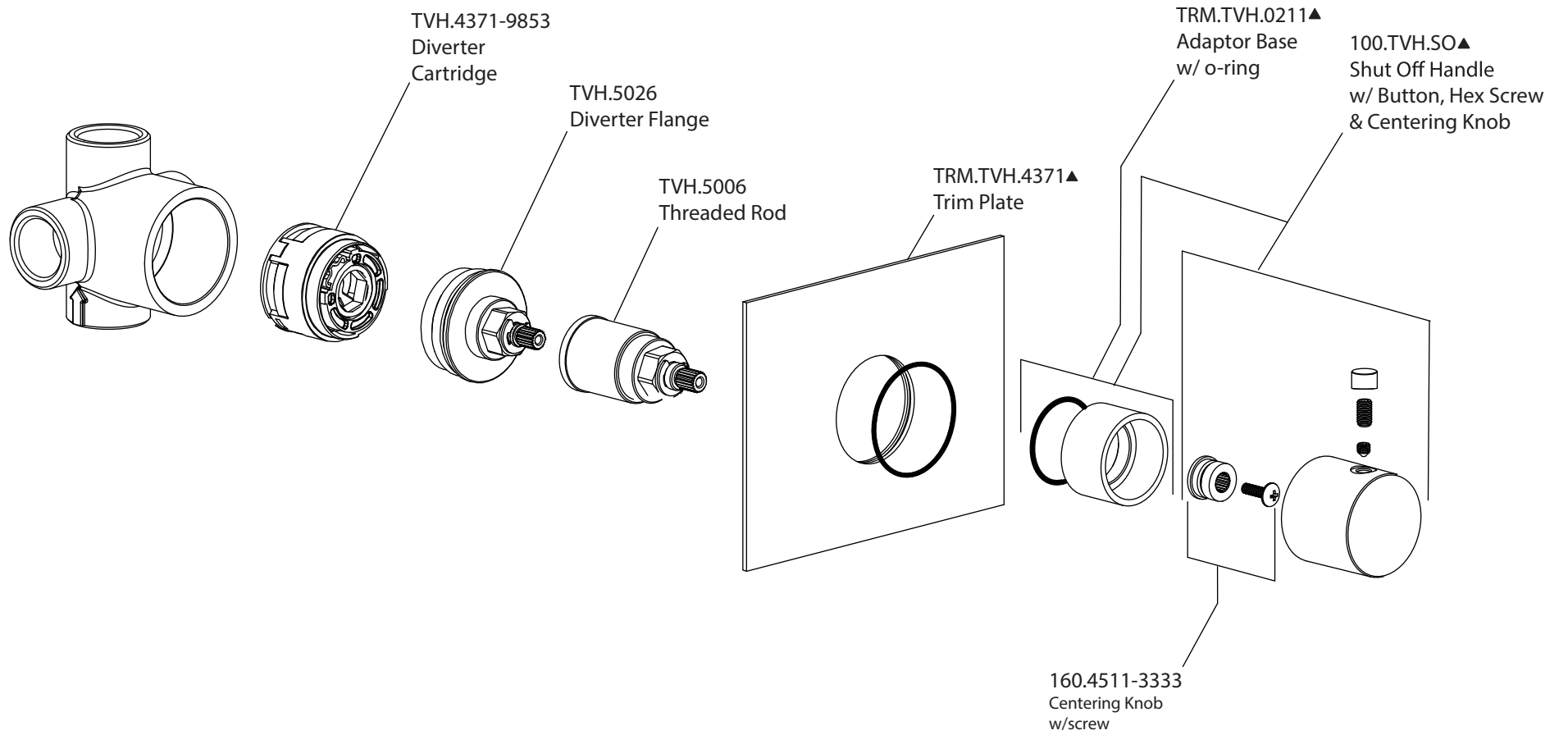

Model No. 100.4371

Ver 2.54