

Product Parts Breakdown

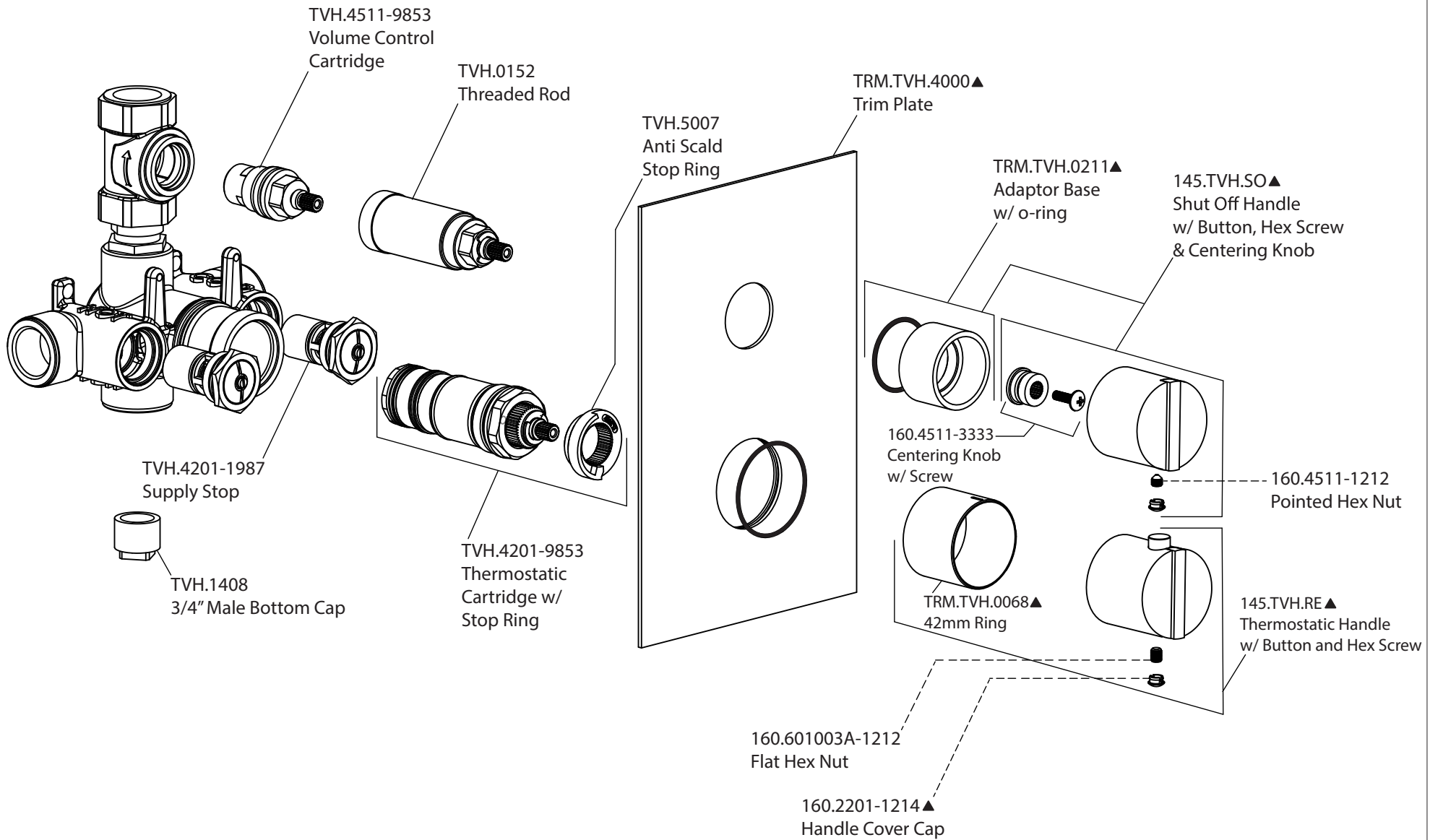

Model No. 145.4101

Ver 2.55