

Product Parts Breakdown

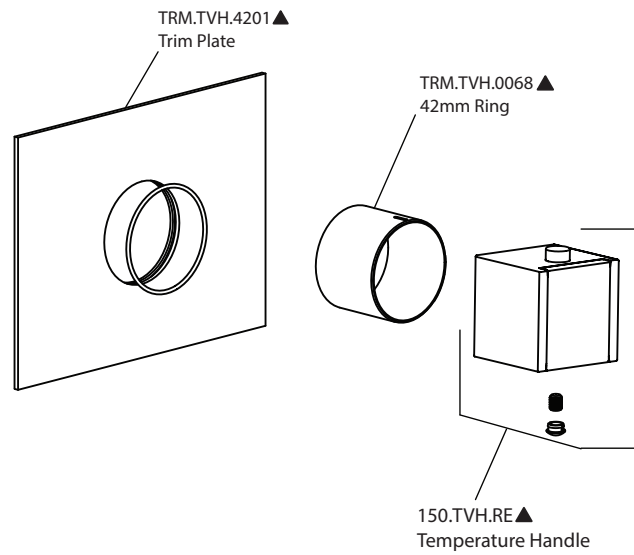

isenberg
innovation+design

150.4201T

Ver 2.53