

Product Parts Breakdown

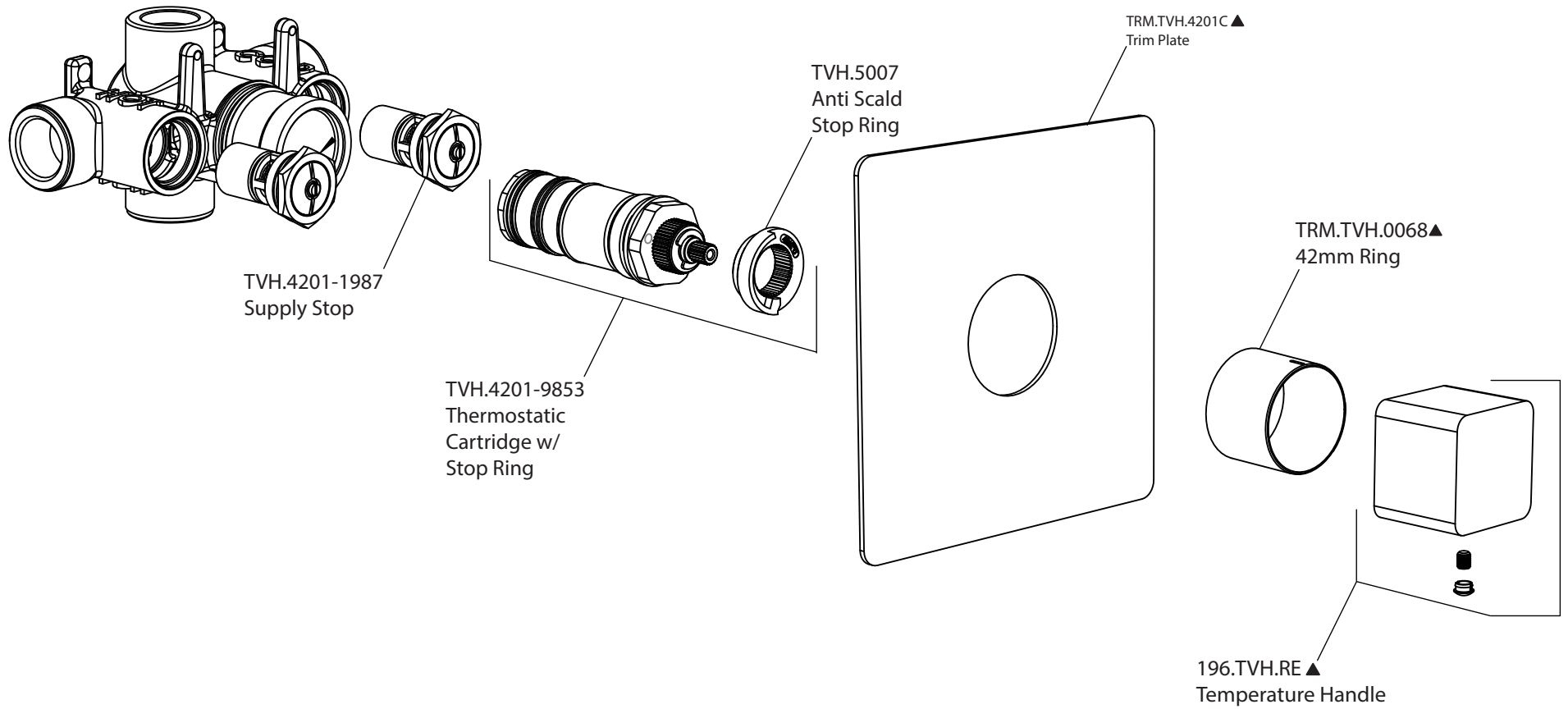

Model No. 196.4201

Ver 2.54