

Product Parts Breakdown

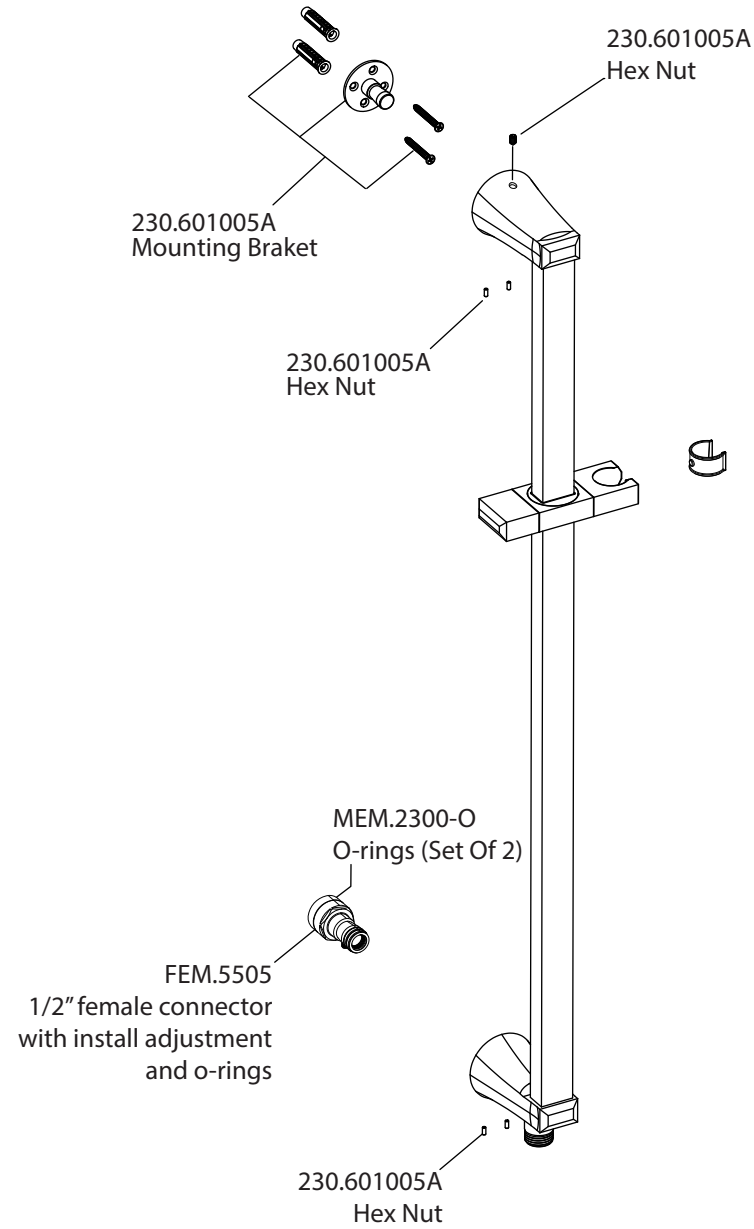

Model No. 230.601005A **Ver** 2.54