

Product Parts Breakdown

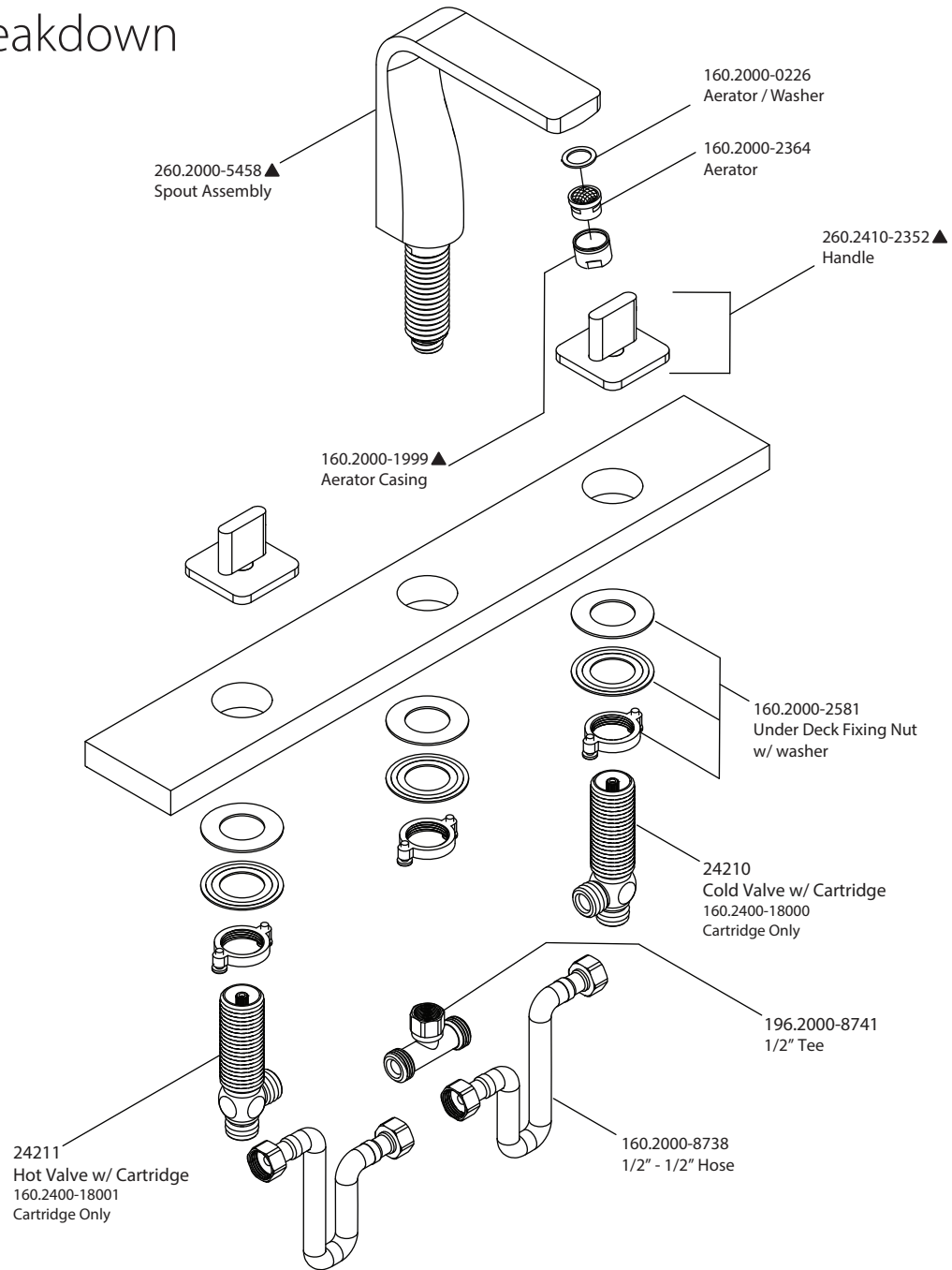

isenberg
innovation+design

260.2000