

Product Parts Breakdown

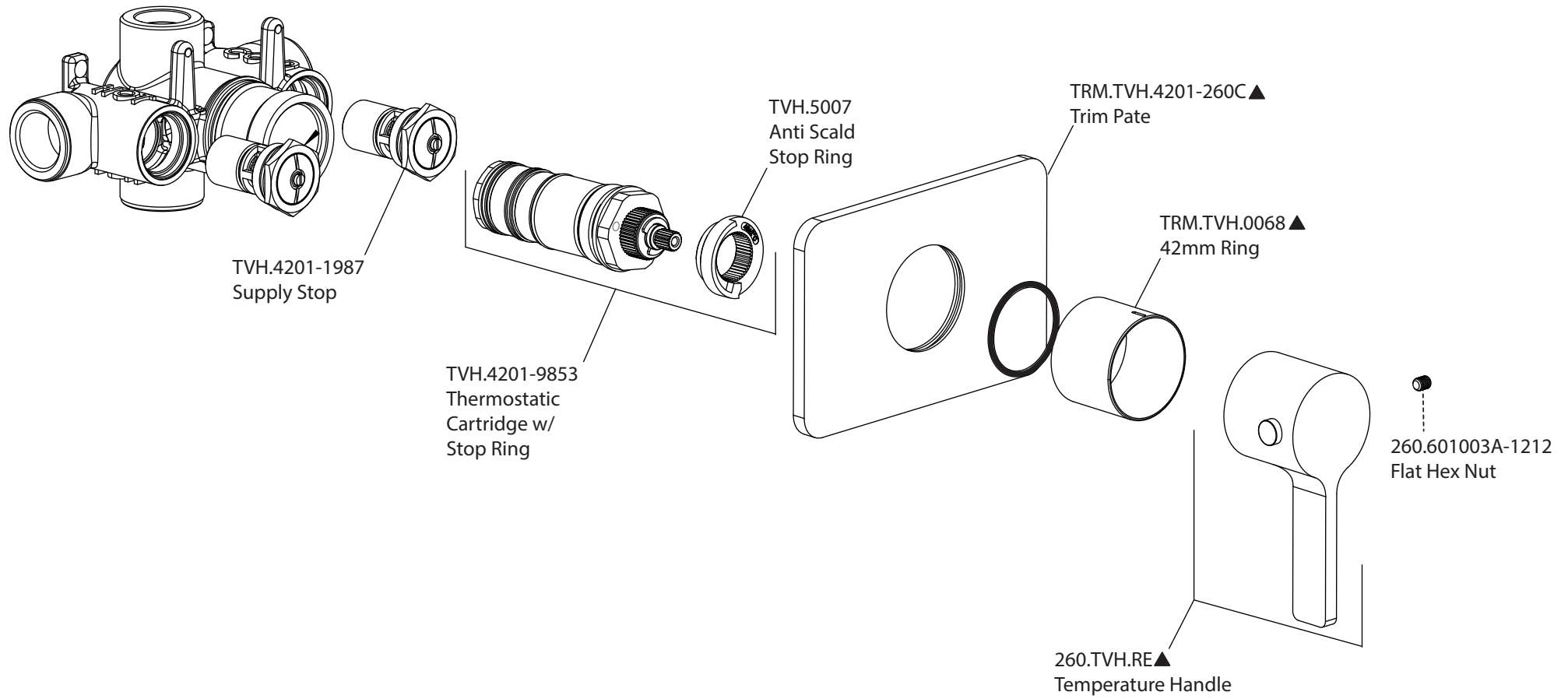

Model No. 260.4201

Ver 2.54