

# Product Parts Breakdown

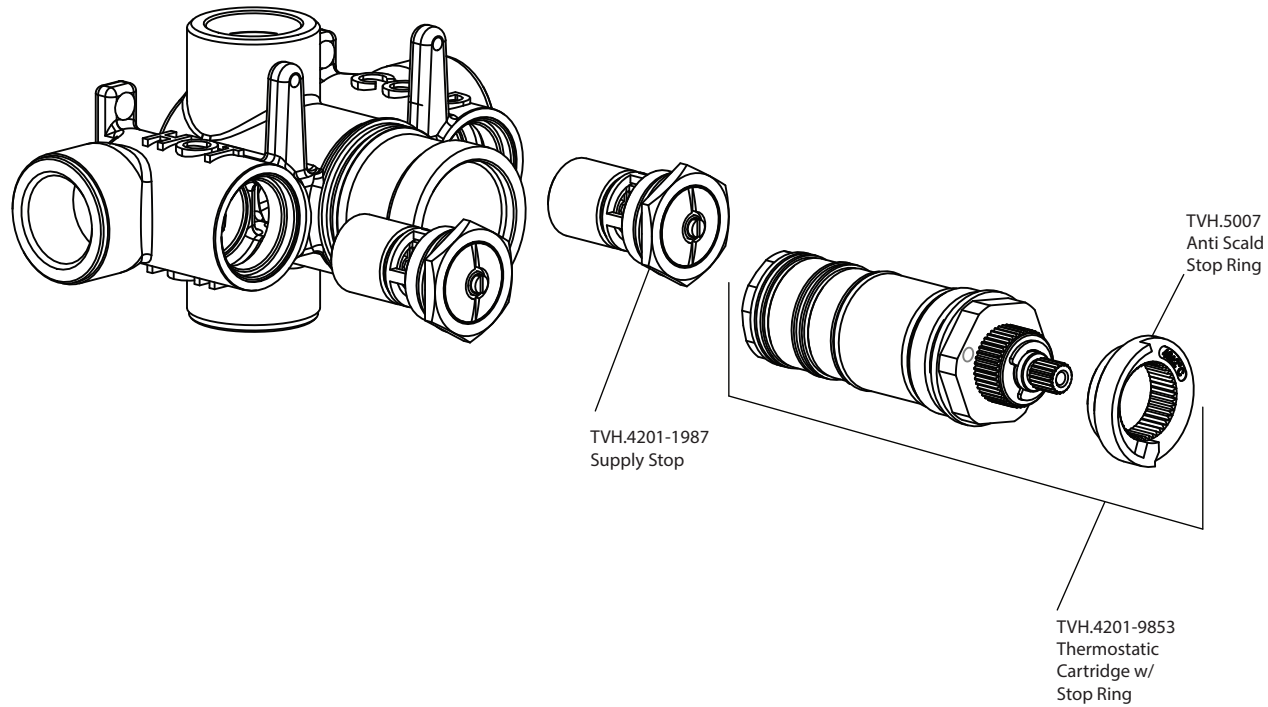

**isenberg**  
innovation+design

TVH.4201

Ver 2.53