

145.1000 | Single Hole Faucet

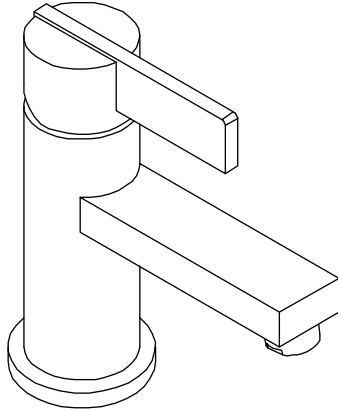

**SPECIFICATIONS:**

- Solid Brass construction
- Single Hole Installation
- 1.2GPM @ 60 PSI
- Ceramic disc cartridge allows both volume and temperature control

**STANDARDS:**

- ASME A112.18.1 / CSA B125.1, NSF-61



Drain Included

**FLOW**  
Efficient

**Technical Diagram**

