

145.2420CF | 5-Hole Deck Mounted Cascade / Sheet Flow Roman Tub Filler

SPECIFICATIONS:

- Solid Brass construction - includes valves DKM.2420
- Spout Projection = 6.1"
- Flow Rate - 8 GPM
- Hand Shower Flow Rate = 1.8 GPM @ 60 PSI w/ back flow prevention
- 1/2" NPT Connection
- Diverter Handle control water flow between cascade and hand held

STANDARDS:

- ASME A112.18.1 / CSA B125.1

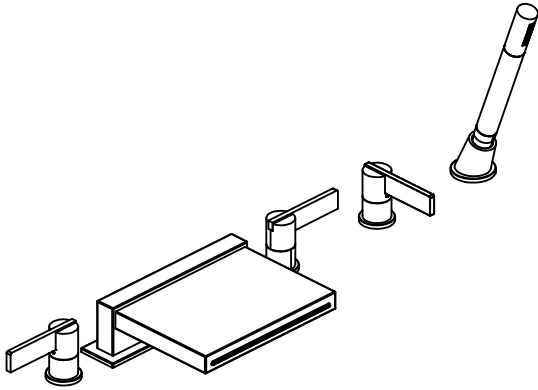

Technical Diagram

